

FLEXILUX UNIVERSAL BORESCOPIES

Ø 4 mm

The Flexilux Universal Line - A modular endoscopy system for rough industrial handling in various applications. Because sometimes it 's good to look at things from a different angle!

Basic Units

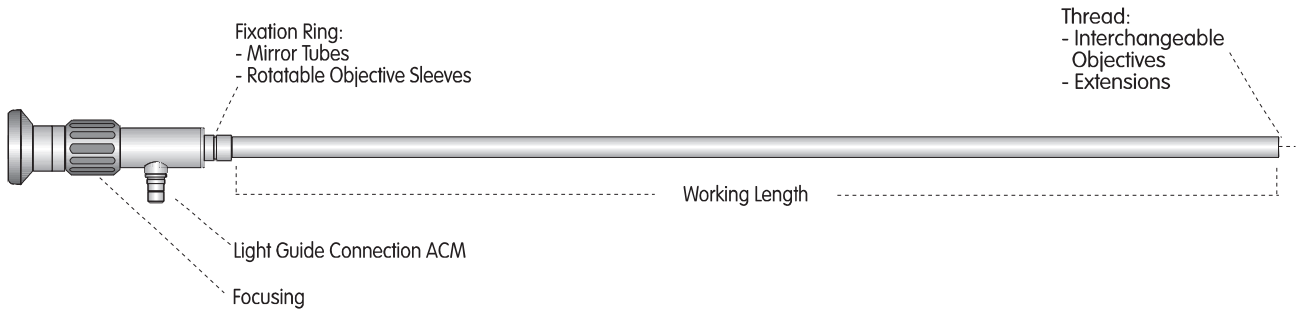

Code No.	Working Length (mm)
FE. 04135	135
FE. 04260	260
FE. 04370	370

Other lengths up to 650 mm on request.

Interchangeable Objectives for Universal Basic Unit

Code No.	Viewing Direction	Field of View	Application	Objective Length (mm)
WO.040010	0°	10°	Tele + high magnification	16.0
WO.040035	0°	35°	For use with mirrors	10.0
WO.040085	0°	85°	Wide angle	13.0
WO.043085	30°	85°	Foroblique view , wide angle	16.0
WO.047085	70°	85°	Foroblique view, wide angle	16.0
WO.049085	90°	85°	Side view, wide angle	13.0

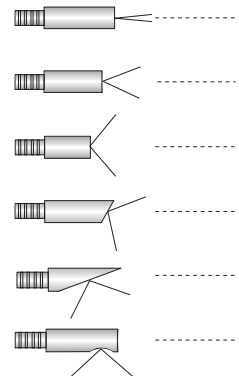

Basic unit has to be used together with objective.



FLEXILUX UNIVERSAL BORESCOPIES

Ø 4 mm

Rotatable Objective Sleeves

The easy way for your all around inspection. Simple snap lock connection to basic unit.



Working diameter incl. objective sleeve = 4.4 mm.

	Code No.	Viewing Direction	Field of View	Length (mm)
	FD.04135.9085	90°	85°	135
	FD.04260.9085	90°	85°	260
	FD.04370.9085	90°	85°	370
	FD.04135.3085	30°	85°	135
	FD.04260.3085	30°	85°	260
	FD.04370.3085	30°	85°	370

Rotatable Mirror Tubes

The ideal accessory for short distance inspection in bores or tubes. Simple snap-lock connection to basic unit (to be used with basic unit + 35° objective). Color-coding for viewing directions: 70°=green, 90°=red, 110°=yellow.

Working diameter incl. mirror tube = 4.4 mm. Length mirror tubes = basic unit + 0/35°objective.

	Code No.	Viewing Direction	Length (mm)
	FS.04145.70	70°	145
	FS.04270.70	70°	270
	FS.04380.70	70°	380
	FS.04145.90	90°	145
	FS.04270.90	90°	270
	FS.04380.90	90°	380
	FS.04145.110	110°	145
	FS.04270.110	110°	270
	FS.04380.110	110°	380

FLEXILUX UNIVERSAL BORESCOPIES

Ø 5.5 mm

The Flexilux Universal Line - A modular borescopes system for rough industrial handling in various applications. Because sometimes it 's good to look at things from a different angle!

Basic Units

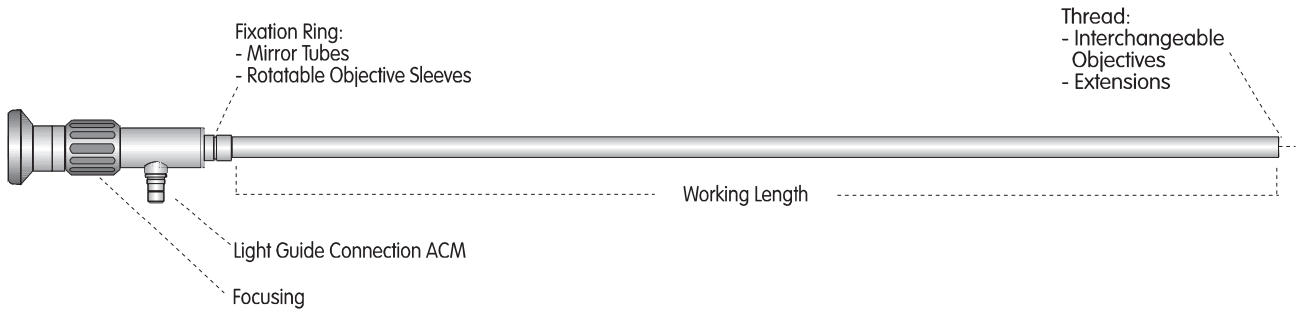

Code No. Working Length (mm)

FE. 55155	155
FE. 55250	250
FE. 55355	355
FE. 55455	455

Other lengths up to 960 mm on request.

Interchangeable Objectives for Universal Basic Unit

Code No.	Viewing Direction	Field of View	Application	Objective Length (mm)
WO.550010	0°	10°	Tele + high magnification	30.0
WO.550040	0°	40°	For use with mirrors	25.0
WO.550085	0°	85°	Wide angle	22.0
WO.554560	45°	60°	Foroblique view	17.0
WO.559060	90°	60°	Side view	21.0
WO.5511060	110°	60°	Retrograde view	21.0

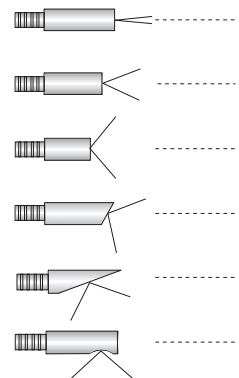

Basic unit has to be used together with objective.



FLEXILUX UNIVERSAL BORESCOPIES

Ø 5.5 mm

Rotatable Objective Sleeves

The easy way for your all around inspection. Simple snap lock connection to basic unit.



Working diameter incl. objective sleeve = 5.9 mm.

	Code No.	Viewing Direction	Field of View	Length (mm)
	FD.55155.9060	90°	60°	155
	FD.55250.9060	90°	60°	250
	FD.55355.9060	90°	60°	355
	FD.55455.9060	90°	60°	455
	FD.55155.4560	45°	60°	155
	FD.55250.4560	45°	60°	250
	FD.55355.4560	45°	60°	355
	FD.55455.4560	45°	60°	455
	FD.55155.11060	110°	60°	155
	FD.55250.11060	110°	60°	250
	FD.55355.11060	110°	60°	355
	FD.55455.11060	110°	60°	45

Rotatable Mirror Tubes

The ideal accessory for short distance inspection in bores or tubes. Simple snap-lock connection to basic unit (to be used with basic unit + 40° objective). Color-coding for viewing directions: 70°=green, 90°=red, 110°=yellow.

Working diameter incl. mirror tube = 5.9 mm. Length mirror tube = basic unit + 0/40° objective.

	Code No.	Viewing Direction	Length (mm)
	FS.55180.70	70°	180
	FS.55275.70	70°	275
	FS.55380.70	70°	380
	FS.55480.70	70°	480
	FS.55180.90	90°	180
	FS.55275.90	90°	275
	FS.55380.90	90°	380
	FS.55480.90	90°	480
	FS.55180.110	110°	180
	FS.55275.110	110°	275
	FS.55380.110	110°	380
	FS.55480.110	110°	480

FLEXILUX UNIVERSAL BORESCOPIES

Ø 8 mm

The Flexilux Universal Line - A modular borescopes system for rough industrial handling in various applications. Because sometimes it 's good to look at things from a different angle!

Basic Units

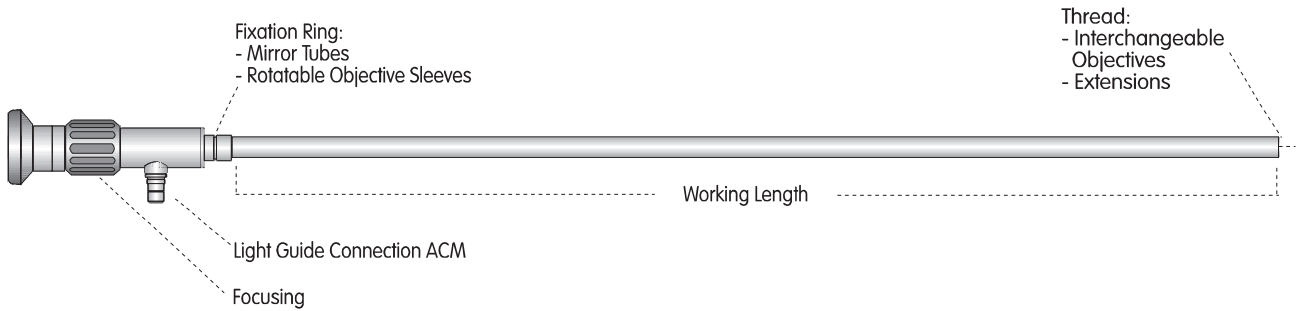

Code No. Working Length (mm)

FE. 08250	250
FE. 08355	355
FE. 08455	455
FE. 08670	670
FE.08950	950

Other lengths up to 1460 mm on request.

Interchangeable Objectives for Universal Basic Unit

Code No.	Viewing Direction	Field of View	Application	Objective Length (mm)
WO.080010	0°	10°	Tele + high magnification	34.0
WO.080040	0°	40°	For use with mirrors	25.0
WO.080085	0°	85°	Wide angle	23.0
WO.084560	45°	60°	Foroblique view	27.0
WO.089060	90°	60°	Side view	26.0
WO.0811060	110°	60°	Retrograde view	26.0

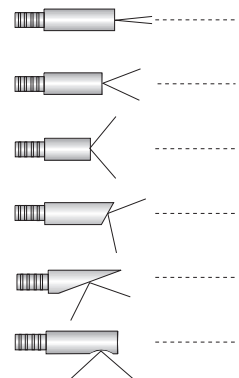

Basic unit has to be used together with objective.



FLEXILUX UNIVERSAL BORESCOPIES

Ø 8 mm

Rotatable Objective Sleeves

The easy way for your all around inspection. Simple snap lock connection to basic unit.



Working diameter incl. objective sleeve = 8.5 mm.

	Code No.	Viewing Direction	Field of View	Length (mm)
	FD.08250.9060	90°	60°	250
	FD.08355.9060	90°	60°	355
	FD.08455.9060	90°	60°	455
	FD.08670.9060	90°	60°	670
	FD.08250.4560	45°	60°	250
	FD.08355.4560	45°	60°	355
	FD.08455.4560	45°	60°	455
	FD.08670.4560	45°	60°	670
	FD.08250.11060	110°	60°	250
	FD.08355.11060	110°	60°	355
	FD.08455.11060	110°	60°	455
	FD.08670.11060	110°	60°	670

Rotatable Mirror Tubes

The ideal accessory for short distance inspection in bores or tubes. Simple snap lock connection to basic unit (to be used with basic unit + 40° objective). Color-coding for viewing directions: 70°=green, 90°=red, 110°=yellow.

Working diameter incl. mirror tube = 8.5 mm. Length mirror tube = basic unit + 0/40° objective.

	Code No.	Viewing Direction	Length (mm)
	FS.08275.70	70°	275
	FS.08380.70	70°	380
	FS.08480.70	70°	480
	FS.08695.70	70°	695
	FS.08275.90	90°	275
	FS.08380.90	90°	380
	FS.08480.90	90°	480
	FS.08695.90	90°	695
	FS.08275.110	110°	275
	FS.08380.110	110°	380
	FS.08480.110	110°	480
	FS.08695.110	110°	695

FLEXILUX UNIVERSAL BORESCOPIES

Ø 10 mm

The Flexilux Universal Line - A modular borescopes system for rough industrial handling in various applications. Because sometimes it 's good to look at things from a different angle!

Basic Units

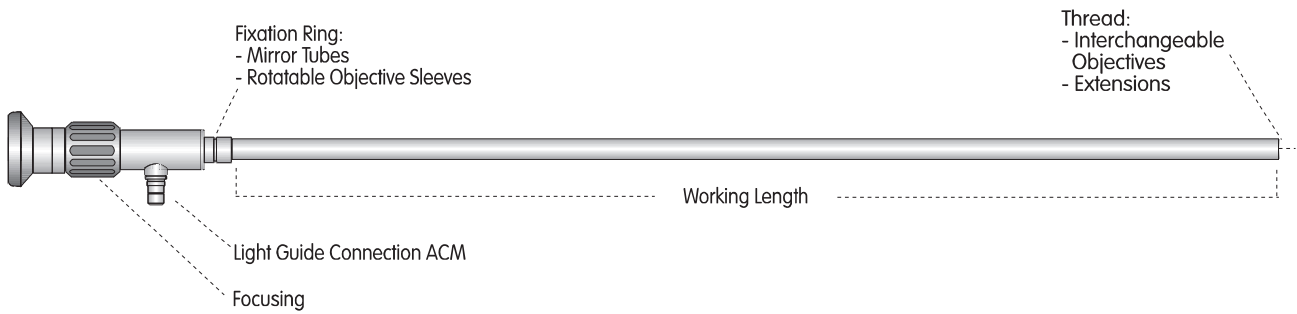

Code No. Working Length (mm)

FE. 10250	250
FE. 10355	355
FE. 10455	455
FE. 10670	670
FE.10950	950

Other lengths up to 1460 mm on request.

Interchangeable Objectives for Universal Basic Unit

Code No.	Viewing	Field of Direction	Application View	Objective Length (mm)
WO.100010	0°	10°	Tele + high magnification	34.0
WO.100040	0°	40°	For use with mirrors	25.0
WO.100085	0°	85°	Wide angle	23.0
WO.104560	45°	60°	Foroblique view	27.0
WO.109060	90°	60°	Side view	26.0
WO.1011060	110°	60°	Retrograde view	26.0

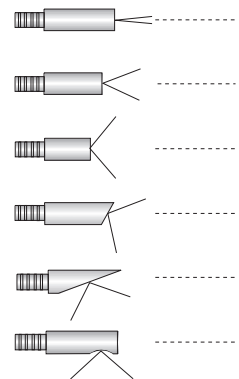

Basic unit has to be used together with objective.



FLEXILUX UNIVERSAL BORESCOPIES

Ø 10 mm

Rotatable Objective Sleeves

The easy way for your all around inspection. Simple snap lock connection to basic unit.



Working diameter incl. objective sleeve = 10.5 mm.

	Code No.	Viewing Direction	Field of View	Length (mm)
	FD.10250.9060	90°	60°	250
	FD.10355.9060	90°	60°	355
	FD.10455.9060	90°	60°	455
	FD.10670.9060	90°	60°	670
	FD.10250.4560	45°	60°	250
	FD.10355.4560	45°	60°	355
	FD.10455.4560	45°	60°	455
	FD.10670.4560	45°	60°	670
	FD.10250.11060	110°	60°	250
	FD.10355.11060	110°	60°	355
	FD.10455.11060	110°	60°	455
	FD.10670.11060	110°	60°	670

Rotatable Mirror Tubes

The ideal accessory for short distance inspection in bores or tubes. Simple snap-lock connection to basic unit (to be used with basic unit + 40° objective). Color-coding for viewing directions: 70°=green, 90°=red, 110°=yellow.

Working diameter incl. mirror tube = 10.5 mm. Length mirror tubes = basic unit + 0/40° objective.

	Code No.	Viewing Direction	Length (mm)
	FS.10275.70	70°	275
	FS.10380.70	70°	380
	FS.10480.70	70°	480
	FS.10695.70	70°	695
	FS.10275.90	90°	275
	FS.10380.90	90°	380
	FS.10480.90	90°	480
	FS.10695.90	90°	695
	FS.10275.110	110°	275
	FS.10380.110	110°	380
	FS.10480.110	110°	480
	FS.10695.110	110°	695

FLEXILUX UNIVERSAL BORESCOPIES

Ø 14 mm

The Flexilux Universal Line - A modular borescopes system for rough industrial handling in various applications. Because sometimes it 's good to look at things from a different angle!

Basic Units

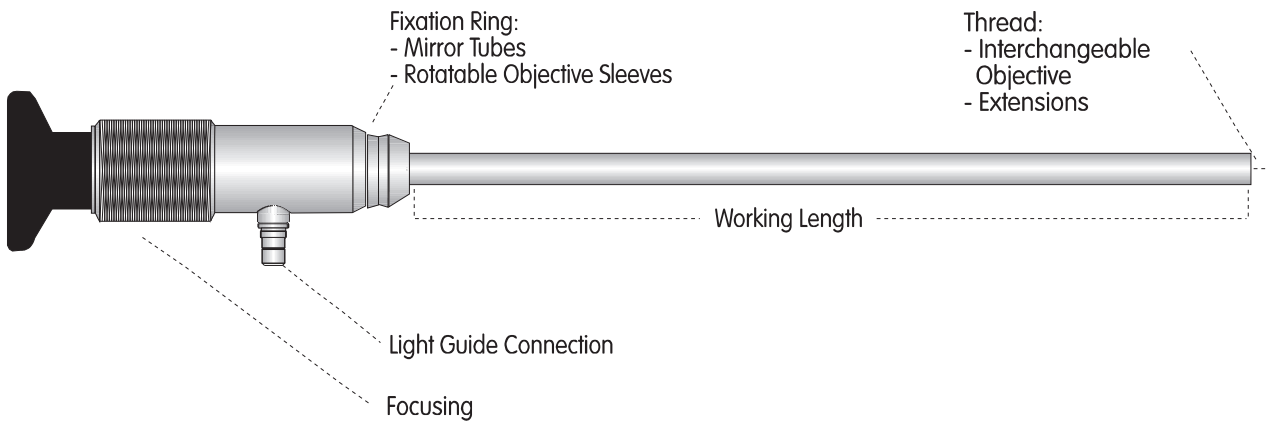

Code No.. Working Length (mm)

FE.14420	420
FE.14685	685
FE.14935	935
FE.141175	1175

Other lengths up to 2180 mm on request.

Interchangeable Objectives for Universal Basic Unit

Code No.	Viewing	Field of Direction	Application View	Objective Length (mm)
----------	---------	--------------------	------------------	-----------------------

WO.140010	0°	10°	Tele + high magnification	42.0
WO.140040	0°	40°	For use with mirrors	40.0
WO.140085	0°	85°	Wide angle	29.0
WO.144560	45°	60°	Foroblique view	38.0
WO.149060	90°	60°	Side view	38.0
WO.1411060	110°	60°	Retrograde view	29.0

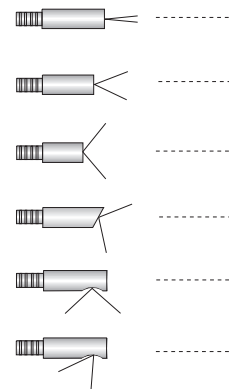

Basic unit has to be used together with objective.



FLEXILUX UNIVERSAL BORESCOPIES

Ø 14 mm

Rotatable Objective Sleeves

The easy way for your all around inspection. Simple connection to basic unit.



Working diameter incl. objective sleeve = 15 mm.

	Code No.	Viewing Direction	Field of View	Length (mm)
	WD.14420.9060	90°	60°	420
	WD.14685.9060	90°	60°	685
	WD.14935.9060	90°	60°	935
	WD.141175.9060	90°	60°	1175
	WD.14420.4560	45°	60°	420
	WD.14685.4560	45°	60°	685
	WD.14935.4560	45°	60°	935
	WD.141175.4560	45°	60°	1175
	WD.14420.11060	110°	60°	420
	WD.14685.11060	110°	60°	685
	WD.14935.11060	110°	60°	935
	WD.141175.11060	110°	60°	1175

Rotatable Mirror Tubes

The ideal accessory for short distance inspection in bores or tubes. Simple connection to basic unit (to be used with basic unit + 40° objective). Color-coding for viewing directions: 70°=green, 90°=red, 110°=yellow.

Working diameter incl. mirror tube = 15 mm. Length mirror tube = basic unit + 0/40° objective.

	Code No.	Viewing Direction	Length (mm)
	WS.14460.70	70°	460
	WS.14725.70	70°	725
	WS.14975.70	70°	975
	WS.141215.70	70°	1215
	WS.14460.90	90°	460
	WS.14725.90	90°	725
	WS.14975.90	90°	975
	WS.141215.90	90°	1215
	WS.14460.110	110°	460
	WS.14725.110	110°	725
	WS.14975.110	110°	975
	WS.141215.110	110°	1215

FLEXILUX UNIVERSAL ACCESSORIES

Flexilux Universal Extensions

In conjunction with the interchangeable objectives of the Universal System this extension can be used to achieve different working lengths for different applications.

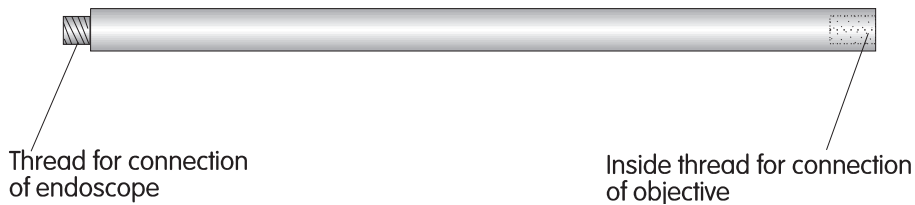

Code No.	Working diameter (mm)	Working length (mm)
WVS.04.120	4,0	120
WVS.04.235	4,0	235
WVS.55.205	5,5	205
WVS.55.415	5,5	415
WVS.08.210	8,0	210
WVS.08.415	8,0	415
WVS.10.415	10,0	415
WVS.10.810	10,0	810
WVS.14.470	14,0	470
WVS.14.995	14,0	995

Flexilux Universal Holder



Ø 22 mm

Code No.	Description
FH.Endogriff.01	Holder for Flexilux borescopes (Compatible with FE- and FF-Series, except FE.14.....)

FLEXILUX UNIVERSAL SYSTEM CHART

